



MPT/MLT 3 400V 3N 50hz

Modular Refrigerated Cabinet

RANGE / CAPACITY

P $-2^{\circ}\text{C} / +8^{\circ}\text{C}$

L $-25^{\circ}\text{C} / -15^{\circ}\text{C}$

TEGLIE **60x3** 

(Passo-Step 50 mm)
Trays : Pastry 600 x 400 mm

TEGLIE **60x3** 

(Passo-Step 140 mm)
Bacinelle/Basin 360x165xH125



Predisposto per gestione magazzino secondo industria **4.0**

Prepared for management warehouse according to industry **4.0**

CARATTERISTICHE

Tecnomac introduce la nuova gamma di Conservatori Modulari, dedicati alla conservazione evoluta .
L'esperienza decennale viene potenziata dal nuovo controllo Touch, che implementa nuove soluzioni di regolazione.
Flusso aria canalizzato.
Nuova scheda elettronica con comandi Touch , tastiera capacitiva ad alta luminosità.
Unità condensante remota.
Spessore isolamento 80 mm (100 mm optional).
Possibilità di memorizzare ricette.

FEATURES

Tecnomac introduces the new range of modular refrigerated cabinets, dedicated to advanced conservation.
The ten-year experience is enhanced by the new Touch control, which implements new regulation solutions.
Canalized air flow.
New electronic board, with Touch display, high brightness and capacitive keyboard.
Remote condensing unit.
Insulation thickness 80 mm (100 mm optional).
Possibility to memorize recipes.

OPTIONAL / OPTIONAL

- Superfici esterne INOX
- Spessore isolamento 100 mm
- Stainless steel external surfaces
- Insulation thickness 100 mm

CONTROLLO & IOT / CONTROL & IOT

Capacitive Full touch 5 "display
Internet ready/cloud/diagnosis
and remote control / IOT e
Industry 4.0 ready / Integrated
network card with Ethernet
output included (WIFI optional)

Display Full touch capacitivo da 5 "
/ Connessione Internet nativa /
cloud / diagnostica e controllo
remoti / IOT e Industry 4.0 ready /
Scheda di rete integrata con uscita
Ethernet inclusa (WIFI opzionale);

CARATTERISTICHE / FEATURES

Alimentazione Elettrica / Power supply	400V/3N/50HZ		400V/3N/50HZ	
	MPT 3		MLT 3	
Codice Prodotto / Code number				
Spessore isolamento / Insulation tickness	80 mm	100 mm	80 mm	100 mm
Lunghezza / leght	2560 mm	2630 mm	2560 mm	2630 mm
Profondità / Depth	1090 mm	1132 mm	1090 mm	1132 mm
Altezza esterna / Height	2390 mm	2475 mm	2390 mm	2475 mm
Regolazione passo teglie / Tray pitch regulation	10 mm	10 mm	10 mm	10 mm
Fluido refrigerante / Refrigeration Fluid	R452A (GWP 2141)	R452A (GWP 2141)	R452A (GWP 2141)	R452A (GWP 2141)
Potenza refrigerante / Cooling power	1715 W	1715 W	2100 W	2100 W
Potenza assorbita / Electric Power	2010 W	2010 W	2080 W	2080 W
Coppie Guide / Pairs of slide	15 x 6	15 x 6	15 x 6	15 x 6
Sbrinamento / Defrost	Automatic	Automatic	Automatic	Automatic

our technology,
your taste

MPT/MLT 3

400V 3N 50hz

Modular Refrigerated Cabinet

DIMENSIONI / DIMENSIONS

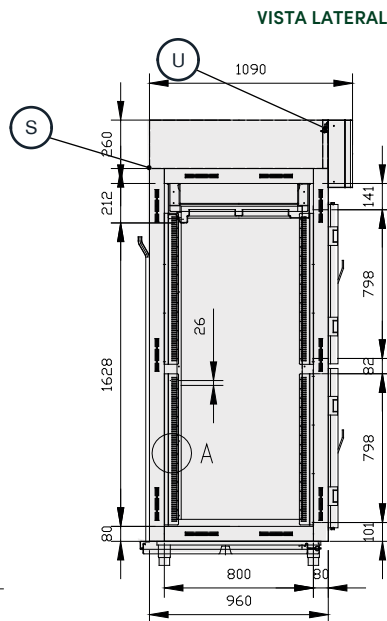
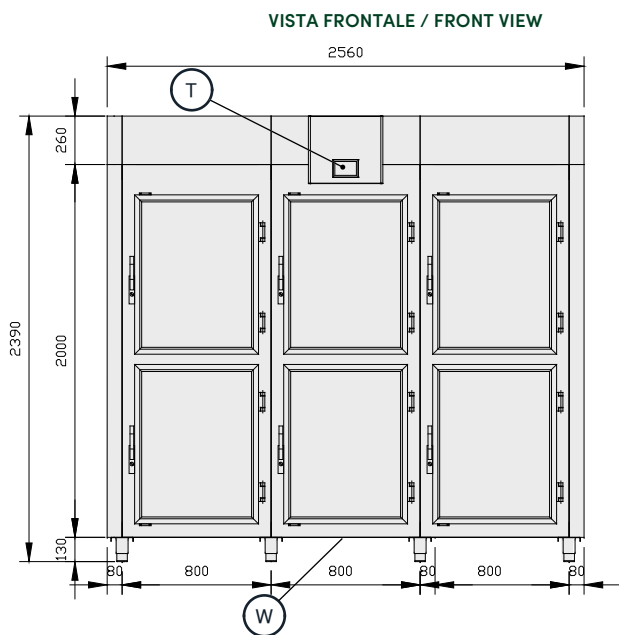



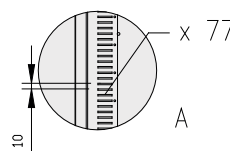
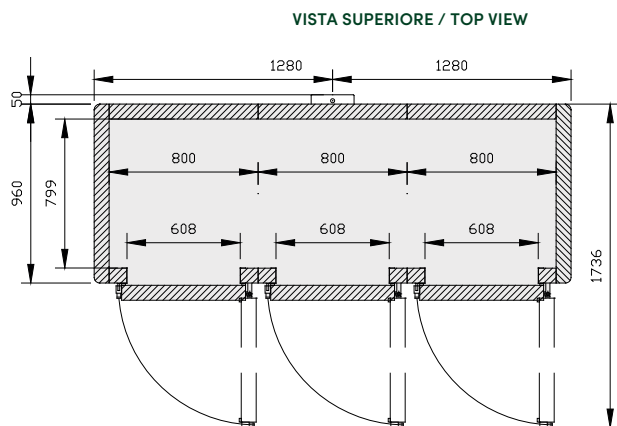

-2°C/+8°C
-25°C/-15°C

SPESSORE ISOLAMENTO
INSULATION THICKNESS

80 mm



-  Cavo alimentazione elettrica
Electrical cable supply
-  Scarico condensa evaporatore
Water evap. discharge
-  Connessione USB
USB Connection 
-  Interfaccia Touch
Touch screen

QUADRO COMANDI / CONTROL PANEL



Orario Hours: 08:24

Tasto Standby Standby button

Tasto freddo continuo Continuous cold button

Tasto Luce Light button







Menù impostazioni Setting menù

Menù ricette Recipes menù

Menù allarmi Notification menu

Menù statistiche Statistics menù

Area avvisi Warning area

-  La porta è aperta
The door is open
-  Cloud connesso (opzionale)
Connected to the cloud (optional)
-  Ventole in funzione
Fan are running
-  Fase di sbrinatorio
Defrost phase
-  Fase risparmio energetico
Energy saving phase
-  Compressore in funzione
Compressor is running